

Selection Guide | VACON® NXP and VACON® NXC AC drives | 0.55 kW – 2 MW

# Precision and clean power in a compact package

**0.55 kW  
to 2 MW**

Full power and  
voltage range for  
both induction and  
permanent magnet  
motors









# Continuous control. Pure power.

VACON® NXP is a premium air-cooled AC drive for use in all applications where reliability, robust performance, precision and power are required. These drives are available in the power range from 0.55 kW to 2,000 kW.

## Ideal for demanding applications

VACON® NXP range offers the ultimate in motor control, for both induction and permanent magnet (PM) motors, gearless drive applications and paralleling solutions for high power motors.

VACON® NXP is the smart drive of choice. With fast fieldbus options and exceptional programming flexibility, your VACON® NXP is easily integrated into any plant's automation system. Satisfied customers also rely on our enclosed cabinet drive solution, VACON® NXC, to perform in the most challenging industrial environments such as oil and gas, extrusion, mining, pulp and paper, water and wastewater applications.

With improved functional safety, extensive approvals in place and

comprehensive maintenance tools, you can be sure that your VACON® AC drives will give you the best possible control and ensure high operational quality and availability over the entire lifetime of your system.

Our VACON® NXP portfolio fulfills key international standards and global requirements, including safety and EMC and Harmonics approvals.

## In harmony with the environment

Our commitment to being an environmentally responsible company is exemplified in our energy-saving products and solutions. We have developed our manufacturing process in order to minimize the impact on the environment. All excess materials in the production and service processes are carefully sorted and recycled.

We continue to develop innovative solutions utilizing regenerative energy and smart grid technology to help customers effectively monitor and control energy use and costs.

## At your service

Whether you are an original equipment manufacturer (OEM), system integrator, brand label customer, distributor or end user, Danfoss Drives provides services to help you meet your business targets. Our global service solutions are available 24/7 throughout the product lifecycle with the intent to minimize the total cost of ownership and environmental load.



VACON® NXP wall-mounted range



VACON® NXP drive modules



VACON® NXC drive cabinets

## VACON® NXP/NXC

Typical segments	Key features	Benefits
<ul style="list-style-type: none"> <li>■ Mining and Minerals</li> <li>■ Compressors</li> <li>■ Marine and Offshore</li> <li>■ Cranes and Hoists</li> <li>■ Metals</li> <li>■ Chemical and Refining</li> <li>■ Water and Wastewater</li> <li>■ Oil and Gas</li> <li>■ Pulp and Paper</li> <li>■ Cement and Gass</li> <li>■ General process industry</li> </ul>	<p>Full power and voltage range from 0.55 kW to 2.0 MW for both induction and permanent magnet motors.</p> <p>Extensive range of ready-to-use applications for basic to demanding needs.</p> <p>Create your own applications with VACON® Programming tool (licensed software tool).</p> <p>Five built-in expansion slots for additional I/O, fieldbus and functional safety boards.</p>	<p>Same software tools, same control and option boards allowing the maximum utilization of VACON® NXP features over a wide power range.</p> <p>No additional software engineering required, saving time and money.</p> <p>Customized applications provide added flexibility to meet process requirements.</p> <p>No additional external modules required. Options boards are compact and easy to install at any time.</p>

# Multiple options



## VACON® NXP Control

VACON® NXP offers a high-performance control platform for all demanding drive applications. The microcontroller provides both exceptional processing power and small footprint. The VACON® NXP supports both induction and permanent magnet motors in open and closed loop control modes. It also provides bumpless control for transferring between open loop and closed loop. VACON® Programming tool can be used to improve performance and save costs by integrating customer-specific functionality into the drive. The same control board is used in all VACON® NXP drives, allowing the maximum utilization of VACON® NXP control features over a wide power and voltage range.



## Option boards

Our VACON® NXP Control provides exceptional modularity by offering five (A, B, C, D and E) plug-in extension slots. Fieldbus boards, encoder boards as well as wide range of IO boards can simply be plugged-in at any time without the need to remove any other components.

*A listing of all options boards is provided on page 21.*



## Fieldbus options

Your VACON® NXP is easily integrated within a plant's automation system by using plug-in fieldbus option boards including PROFIBUS DP, Modbus RTU, DeviceNet and CANopen. Fieldbus technology ensures increased control and monitoring of the process equipment with reduced cabling – ideal for industries where the need to ensure that products are produced under the right conditions is of paramount importance. An external +24 V supply option enables communication with the control unit even if the main supply is switched off. Fast drive-to-drive communication is possible using our fast SystemBus fiber optic communication.

**Profibus DP | DeviceNet | Modbus RTU | CANopen**



## Ethernet connectivity

VACON® NXP is the smart drive of choice, as there is no need to purchase additional communication tools. Ethernet connectivity allows remote drive access for monitoring, configuring and troubleshooting. Our Ethernet protocols such as PROFINET IO, EtherNet/IP and Modbus/TCP are available for all VACON® NXP drives. New Ethernet protocols are being continuously developed.

**Modbus/TCP | PROFINET IO + System Redundancy S2 and PROFISAFE | EtherNet/IP**

# Functional safety

## Advanced Safety Options

The VACON Advanced Safety Options operate the safety functions of an AC drive via the PROFIsafe fieldbus or I/O control. They improve flexibility by connecting safety devices within a plant.

### Safe Stop functions

- STO – Safe Torque Off
- SS1 – Safe Stop 1
- SS2 – Safe Stop 2
- SBC – Safe Brake Control
- SQS – Safe Quick Stop

### Safe Speed functions

- SLS – Safely-limited Speed
- SSM – Safe Speed Monitor
- SSR – Safe Speed Range
- SMS – Safe Maximum Speed



## ATEX certified thermistor input

An ATEX approved thermistor input is available as an integrated option. Certified and compliant with the European ATEX directive 94/9/EC, the integrated thermistor input is specially designed for the temperature supervision of motors that are placed in areas in which potentially explosive gas, vapor, mist or air mixtures are present and areas with combustible dust. Typical industries requiring such supervision include chemical, petrochemical, marine, metal, mechanical, mining, and oil drilling.

If over-heating is detected, the drive immediately stops feeding energy to the motor. As no external components are needed, the cabling is minimized, improving reliability and saving on both space and costs.



## DC cooling fans

VACON® NXP high-performance air-cooled products are equipped with DC fans. This significantly increases the reliability and lifetime of the fan also fulfilling the ERP2015 directive on decreasing fan losses. Likewise, the DC-DC supply board component ratings fulfill industrial requirement levels.



## Conformal coating

To increase performance and durability, conformally coated circuit boards (also known as varnished boards) are provided as standard for power modules (FR7 - FR14).

The upgraded boards offer reliable protection against dust and moisture and extend the lifetime of the drive and critical components.



# Commissioning made easy



## User-friendly keypad

The user interface is intuitive to use. You will enjoy the keypad's well-structured menu system that allows for fast commissioning and trouble-free operation.

- Removable panel with plug-in connection
- Graphical and text keypad with multiple language support
- Text display multi-monitoring function
- Parameter backup and copy function with the panel's internal memory
- The startup wizard ensures a hassle-free set up. Choose the language, application type and main parameters during the first power-up.



## Documentation wizard

Make use of our VACON® Documentation Wizard and achieve dramatic savings in engineering time. The Documentation Wizard is a technical documentation tool, which creates a complete set of drawings for each VACON® NXC configuration. Just enter the product information, i.e. a type code, required variations and extra equipment (plus codes) into the user interface field, and the tool will automatically generate the documentation in any of the following formats: DWG (AutoCAD) drawings, DXF (AutoCAD) drawings, PDF (Adobe reader) and E-plan project (prj).

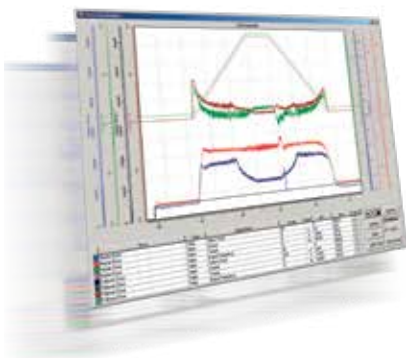

## VACON® NCDrive

VACON® NCDrive is used for setting, copying, storing, printing, monitoring and controlling parameters. The VACON® NCDrive communicates with the drive via the following interfaces: RS-232, Ethernet TCP/IP, CAN (fast multiple drive monitoring), CAN@Net (remote monitoring).

VACON® NCDrive also includes a handy Datalogger function, which offers you the possibility to monitor and analyze data.

**PC-tools can be downloaded from <http://drives.danfoss.com>**

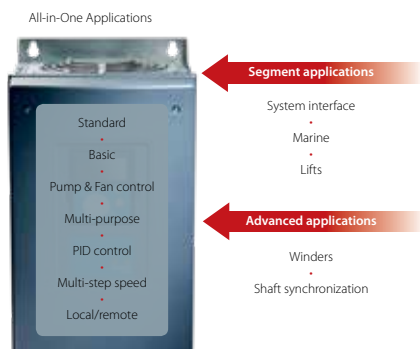

## All-in-one application package

The All-in-One application package has seven built-in software applications, which can be selected with one parameter.

In addition to the All-in-One package, we offer several segment specific and advanced applications such as System Interface application, Marine application, Lift application and Shaft Synchronisation application for more demanding uses.

**VACON® NXP applications can be downloaded from <http://drives.danfoss.com>**

# High power and improved redundancy

VACON® DriveSync is our innovative control concept for running standard drives in parallel to control high-power AC motors or increase the redundancy of a system. This concept suits single or multiple winding motors typically above 1 MW.

Powerful AC drives can be built using standard drive components and have the following benefits:

- The system is modular and easy to extend
- High total power can be obtained by combining smaller drives
- System redundancy is higher than in a conventional drive because each unit can run independently
- Individual drive is easy to maintain and service
- Identical units reduce the required amount of spare parts thus reducing overall costs
- No special skills are required for the engineering, installation, commissioning and maintenance of drives as they are comprised of standard modules
- It is possible to run multiple winding motors with a phase shift between the windings

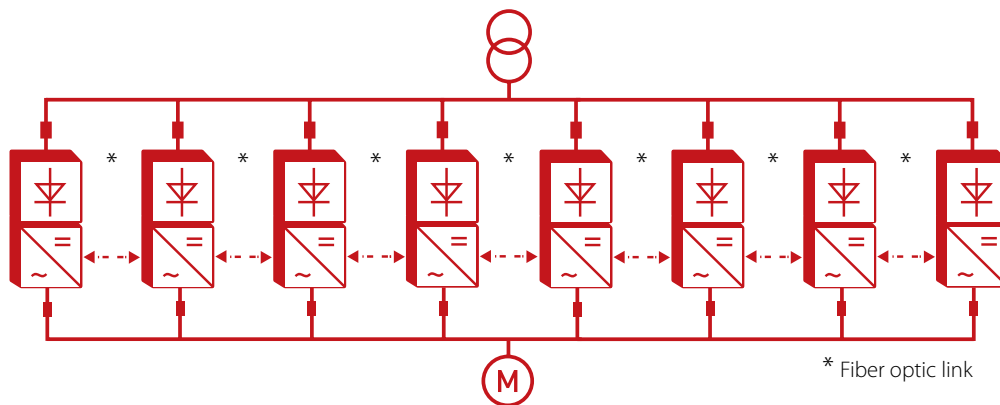

Example of the VACON® DriveSync configuration.

## Typical VACON® DriveSync examples using VACON® NXP/NXC drives

Mains voltage	AC drive type	Loadability				Maximum current I <sub>s</sub> [A]	Motor shaft power		Frame size	Dimensions and weight W x H x D (mm)/kg
		Low (+40°C)		High (+50°C)			400 V supply			
		Rated continuous current I <sub>r</sub> [A]	10% overload current [A]	Rated continuous current I <sub>r</sub> [A]	50% overload current [A]		10% overload P [kW]	50% overload P [kW]		
380-500 V 50/60 Hz	2 x NXC 1150 5 A 2 L 0 SSF	2150	2365	1940	2910	3492	1200	1100	2 x FR13	1606 x 2275 x 605/1350
	2 x NXC 1300 5 A 2 L 0 SSF	2470	2717	2185	3278	3933	1350	1100		
	2 x NXC 1450 5 A 2 L 0 SSF	2755	3031	2470	3705	4446	1500	1350		
	3 x NXC 1150 5 A 2 L 0 SSF	3278	3605	2936	4403	5284	1800	1500	3 x FR13	1606 x 2275 x 605/1350
	3 x NXC 1300 5 A 2 L 0 SSF	3705	4076	3278	4916	5900	2000	1800		
	3 x NXC 1450 5 A 2 L 0 SSF	4133	4546	3705	5558	6669	2250	2000		

Values are given at switching frequency 2.0 kHz.

Mains voltage	AC drive type	Loadability				Maximum current I <sub>s</sub> [A]	Motor shaft power		Frame size	Dimensions and weight W x H x D (mm)/kg
		Low (+40°C)		High (+50°C)			690 V supply			
		Rated continuous current I <sub>r</sub> [A]	10% overload current [A]	Rated continuous current I <sub>r</sub> [A]	50% overload current [A]		10% overload P [kW]	50% overload P [kW]		
525-690 V 50/60 Hz	2 x NXC 0920 6 A 2 L 0 SSF	1748	1920	1500	2337	2679	1710	1520	2 x FR13	1406 x 2275 x 605/1250
	2 x NXC 1030 6 A 2 L 0 SSF	1810	2000	1500	2337	2679	1710	1520		
	2 x NXC 1180 6 A 2 L 0 SSF*	1950	2140	1630	2500	3335	1900	1610		
	3 x NXC 0920 6 A 2 L 0 SSF	2622	2884	2337	3490	4019	2500	2200	3 x FR13	1406 x 2275 x 605/1250
	3 x NXC 1030 6 A 2 L 0 SSF	2706	3000	2337	3490	4019	2500	2200		
	3 x NXC 1180 6 A 2 L 0 SSF*	2910	3210	2500	3735	5002	2800	2410		

\*Max. ambient temperature of +35°C.  
Values are given at switching frequency 2.0 kHz.



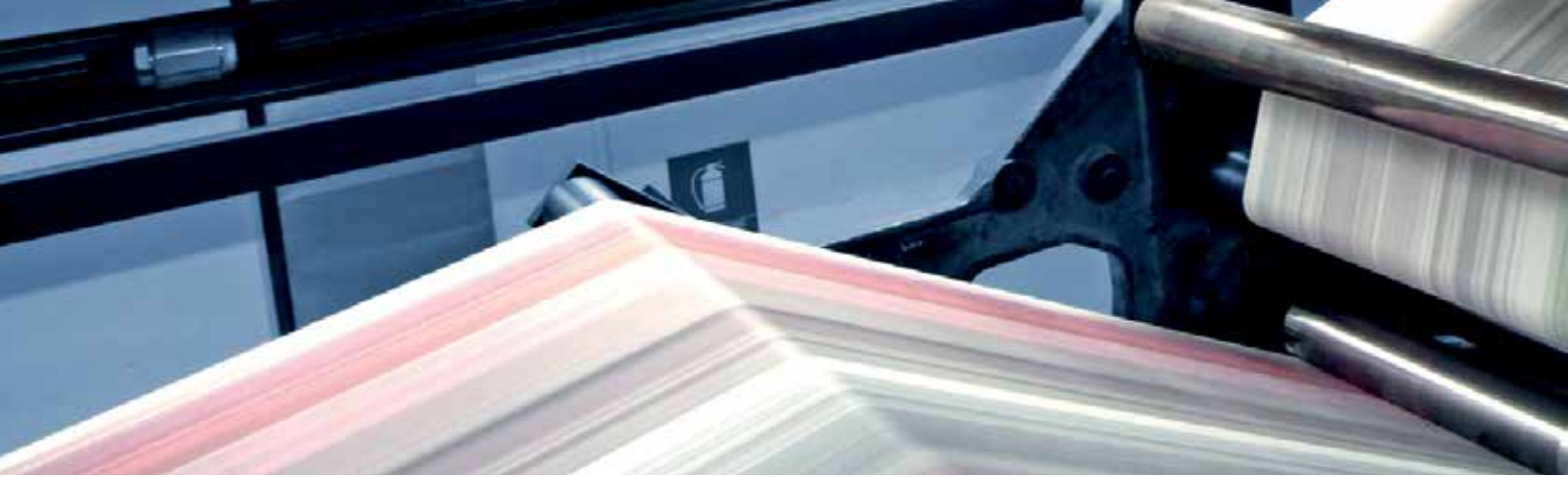

## VACON® NXP wall-mounted

The VACON® NXP wall-mounted is one of the most compact and comprehensive drive packages on the market, with all the necessary components integrated in a single frame. For the lower power range, VACON® NXP drives are available in a compact IP21 or IP54 frame.

### Fully equipped

VACON® NXP wall-mounted units are equipped with internal EMC filtering and the power electronics are integrated into an all-metal frame. The smaller frame sizes (FR4-FR6) have an integrated brake chopper as standard and the 380-500 V units can be equipped with an integrated brake resistor. The larger frames (FR7-FR12) can be equipped with an integrated brake chopper as an option.

### Typical applications

- Elevators and escalators
- Cranes and hoists
- Winches and cargo pumps
- Pumps and fans
- Conveyors
- Machine tools
- Yaw and pitch control
- Oil pumps
- Winders and unwinders
- Pulp dryers
- Tissue machinery
- Extruders

### Features

- Complete voltage range 230...690 V AC
- Removable panel with parameter back-up function
- Common control board
- Built-in I/O expandability, 5 slots available and option boards in all frame sizes
- Marine type approvals and functional safety features
- Integrated brake chopper as standard in FR4-6, 380-500 V units.

### Benefits

- One type of drive for wide power and voltage range reduces the complexity and the need for additional training
- Easier commissioning – saves time
- Same software tools and applications for the entire range
- Compact and easy to install – saves time and money
- System complexity can be reduced saving engineering time and costs



VACON® NXP (FR8)

VACON® NXP (FR7)





## Ratings and dimensions

Mains voltage	AC drive type	Loadability				Maximum current I <sub>s</sub> [A]	Motor shaft power		Frame size	Dimensions and weight W x H x D (mm)/ kg
		Low (+40°C)		High (+50°C)			230 V / 400 V / 690 V			
		Rated continuous current I <sub>r</sub> [A]	10% overload current [A]	Rated continuous current I <sub>r</sub> [A]	50% overload current [A]		10% overload P [kW]	50% overload P [kW]		
208-240 V 50/60 Hz 3 <sup>~</sup>	NXP 0003 2 A 2 H 1 S S S	3.7	4.1	2.4	3.6	4.8	0.55	0.37	FR4	128 x 292 x 190/5
	NXP 0004 2 A 2 H 1 S S S	4.8	5.3	3.7	5.6	7.4	0.75	0.55		
	NXP 0007 2 A 2 H 1 S S S	6.6	7.3	4.8	7.2	9.6	1.1	0.75		
	NXP 0008 2 A 2 H 1 S S S	7.8	8.6	6.6	9.9	13.2	1.5	1.1		
	NXP 0011 2 A 2 H 1 S S S	11	12.1	7.8	11.7	15.6	2.2	1.5		
	NXP 0012 2 A 2 H 1 S S S	12.5	13.8	11	16.5	22	3	2.2		
	NXP 0017 2 A 2 H 1 S S S	17.5	19.3	12.5	18.8	25	4	3	FR5	144 x 391 x 214/8.1
	NXP 0025 2 A 2 H 1 S S S	25	27.5	17.5	26.3	35	5.5	4		
	NXP 0031 2 A 2 H 1 S S S	31	34.1	25	37.5	50	7.5	5.5	FR6	195 x 519 x 237/18.5
	NXP 0048 2 A 2 H 1 S S S	48	52.8	31	46.5	62	11	7.5		
	NXP 0061 2 A 2 H 1 S S S	61	67.1	48	72	96	15	11	FR7	237 x 591 x 257/35
	NXP 0075 2 A 2 H 0 S S S	75	83	61	92	122	22	15		
	NXP 0088 2 A 2 H 0 S S S	88	97	75	113	150	22	22	FR8	291 x 758 x 344/58
	NXP 0114 2 A 2 H 0 S S S	114	125	88	132	176	30	22		
	NXP 0140 2 A 2 H 0 S S S	140	154	105	158	210	37	30	FR9	480 x 1150 x 362/146
	NXP 0170 2 A 2 H 0 S S S	170	187	140	210	280	45	37		
	NXP 0205 2 A 2 H 0 S S S	205	226	170	255	336	55	45	FR9	480 x 1150 x 362/146
	NXP 0261 2 A 2 H 0 S S F	261	287	205	308	349	75	55		
NXP 0300 2 A 2 H 0 S S F	300	330	245	368	444	90	75			
380-500 V 50/60 Hz 3 <sup>~</sup>	NXP 0003 5 A 2 H 1 S S S	3.3	3.6	2.2	3.3	4.4	1.1	0.75	FR4	128 x 292 x 190/5
	NXP 0004 5 A 2 H 1 S S S	4.3	4.7	3.3	5	6.2	1.5	1.1		
	NXP 0005 5 A 2 H 1 S S S	5.6	6.2	4.3	6.5	8.6	2.2	1.5		
	NXP 0007 5 A 2 H 1 S S S	7.6	8.4	5.6	8.4	10.8	3	2.2		
	NXP 0009 5 A 2 H 1 S S S	9	9.9	7.6	11.4	14	4	3		
	NXP 0012.5 A 2 H 1 S S S	12	13.2	9	13.5	18	5.5	4		
	NXP 0016 5 A 2 H 1 S S S	16	17.6	12	18	24	7.5	5.5	FR5	144 x 391 x 214/8.1
	NXP 0022 5 A 2 H 1 S S S	23	25.3	16	24	32	11	7.5		
	NXP 0031 5 A 2 H 1 S S S	31	34	23	35	46	15	11	FR6	195 x 519 x 237/18.5
	NXP 0038 5 A 2 H 1 S S S	38	42	31	47	62	18.5	15		
	NXP 0045 5 A 2 H 1 S S S	46	51	38	57	76	22	18.5	FR7	237 x 591 x 257/35
	NXP 0061 5 A 2 H 1 S S S	61	67	46	69	92	30	22		
	NXP 0072 5 A 2 H 0 S S S	72	79	61	92	122	37	30	FR8	291 x 758 x 344/58
	NXP 0087 5 A 2 H 0 S S S	87	96	72	108	144	45	37		
	NXP 0105 5 A 2 H 0 S S S	105	116	87	131	174	55	45	FR9	480 x 1150 x 362/146
	NXP 0140 5 A 2 H 0 S S S	140	154	105	158	210	75	55		
	NXP 0168 5 A 2 H 0 S S S	170	187	140	210	280	90	75	FR9	480 x 1150 x 362/146
	NXP 0205 5 A 2 H 0 S S S	205	226	170	255	336	110	90		
NXP 0261 5 A 2 H 0 S S F	261	287	205	308	349	132	110			
NXP 0300 5 A 2 H 0 S S F	300	330	245	368	444	160	132			
525-690 V 50/60 Hz 3 <sup>~</sup>	NXP 0004 6 A 2 L 0 S S S	4.5	5	3.2	4.8	6.4	3	2.2	FR6	195 x 519 x 237/18.5
	NXP 0005 6 A 2 L 0 S S S	5.5	6.1	4.5	6.8	9	4	3		
	NXP 0007 6 A 2 L 0 S S S	7.5	8.3	5.5	8.3	11	5.5	4		
	NXP 0010 6 A 2 L 0 S S S	10	11	7.5	11.3	15	7.5	5.5		
	NXP 0013 6 A 2 L 0 S S S	13.5	14.9	10	15	20	11	7.5		
	NXP 0018 6 A 2 L 0 S S S	18	19.8	13.5	20.3	27	15	11		
	NXP 0022 6 A 2 L 0 S S S	22	24.2	18	27	36	18.5	15	FR7	237 x 591 x 257/35
	NXP 0027 6 A 2 L 0 S S S	27	29.7	22	33	44	22	18.5		
	NXP 0034 6 A 2 L 0 S S S	34	37	27	41	54	30	22	FR8	291 x 758 x 344/58
	NXP 0041 6 A 2 L 0 S S S	41	45	34	51	68	37.5	30		
	NXP 0052 6 A 2 L 0 S S S	52	57	41	62	82	45	37.5	FR9	480 x 1150 x 362/146
	NXP 0062 6 A 2 L 0 S S S	62	68	52	78	104	55	45		
	NXP 0080 6 A 2 L 0 S S S	80	88	62	93	124	75	55		
	NXP 0100 6 A 2 L 0 S S S	100	110	80	120	160	90	75		
NXP 0125 6 A 2 L 0 S S F	125	138	100	150	200	110	90	FR9	480 x 1150 x 362/146	
NXP 0144 6 A 2 L 0 S S F	144	158	125	188	213	132	110			
NXP 0170 6 A 2 L 0 S S F	170	187	144	216	245	160	132			
NXP 0208 6 A 2 L 0 S S F	208	229	170	255	289	200	160			



# VACON® NXP drive module

VACON® NXP high-power IP00 drive modules are intended for installation into a cabinet, switchgear or any separate enclosure. Module installation in standard enclosures is easy given the compact design.

## Designed to fit

VACON® NXP drive modules of frame size FR10 – FR12 embody one (FR10 and FR11) or two (FR12) power modules. VACON® NXP frame sizes FR13 – FR14 comprise two to four non-regenerative front-end (NFE) units and one (FR13) or two (FR14) inverter units. External AC chokes are also included in the delivery. The VACON® NXP modules are available as both 6-pulse and 12-pulse supply versions.

## Typical applications

- Conveyors
- Cranes and lifts
- High-speed compressors
- Ski lifts
- Main propulsion and bow thrusters
- Extruders
- Winches & cargo pumps
- Oil pumps
- Test benches
- Static power supply
- Grinders and mixers
- Winders and unwinders
- Chippers
- Tunneling Machines

## Features

- Easy cabinet integration with additional assembly kits
- One of the smallest on the market
- Extensive marine type approvals
- VACON® DriveSynch features

## Benefits

- With optimized module design, less engineering is needed saving time and money
- Compact module size require less cabinet space, while reducing the overall costs
- Improved redundancy and higher powers up to 5 MW



VACON® NXP drive module (FR10)

## Hardware configurations

Function	Availability
Integrated control	Standard
External control	Optional
Integrated brake chopper	Optional (FR 10-12)
6-Pulse Supply	Standard
12-Pulse Supply	Optional
EMC filtering N	Standard
EMC filtering T (for IT -networks)	Optional
AC choke	Standard
Output filters dU/dt, Sine and common mode	Optional



## Ratings and dimensions

Mains voltage	AC drive type	Loadability				Maximum current I <sub>s</sub> [A]	Motor shaft power		Frame size	Module W x H x D (mm)/ kg	Chokes W x H x D (mm)/ kg
		Low (+40°C)		High (+40°C)			400 V / 690 V				
		Rated continuous current I <sub>r</sub> [A]	10% overload current [A]	Rated continuous current I <sub>r</sub> [A]	50% overload current [A]		10% overload P [kW]	50% overload P [kW]			
380-500 V 50/60 Hz 3 <sup>~</sup>	NXP 0385 5 A 0 N 0 SSA	385	424	300	450	540	200	160	FR10	500 x 1165 x 506/120	350 x 383 x 262/84 <sup>1)</sup> 497 x 399 x 244/115 <sup>1)</sup> 497 x 399 x 244/115 <sup>1)</sup>
	NXP 0460 5 A 0 N 0 SSA	460	506	385	578	693	250	200			
	NXP 0520 5 A 0 N 0 SSA*	520	572	460	690	828	250	250			
	NXP 0590 5 A 0 N 0 SSA	590	649	520	780	936	315	250	FR11	709 x 1206 x 506/210	2 x (350 x 383 x 262/84)
	NXP 0650 5 A 0 N 0 SSA	650	715	590	885	1062	355	315			
	NXP 0730 5 A 0 N 0 SSA	730	803	650	975	1170	400	355			
	NXP 0820 5 A 0 N 0 SSA	820	902	730	1095	1314	450	400	FR12	2 x (500 x 1165 x 506/120)	2 x (497 x 399 x 244/115)
	NXP 0920 5 A 0 N 0 SSA	920	1012	820	1230	1476	500	450			
	NXP 1030 5 A 0 N 0 SSA	1030	1133	920	1380	1656	560	500			
	NXP 1150 5 A 0 N 0 SSF	1150	1265	1030	1545	1854	630	560	FR13	2 x (239 x 1030 x 372/67) + 1 x (708 x 1030 x 553/302)	2 x (497 x 449 x 249/130)
NXP 1300 5 A 0 N 0 SSF	1300	1430	1150	1725	2070	710	630				
NXP 1450 5 A 0 N 0 SSF	1450	1595	1300	1950	2340	800	710				
NXP 1770 5 A 0 N 0 SSF	1770	1947	1600	2400	2880	1000	900	FR14	4 x (239 x 1030 x 372/67) + 2 x (708 x 1032 x 553/302)	4 x (497 x 449 x 249/130)	
NXP 2150 5 A 0 N 0 SSF	2150	2365	1940	2910	3492	1200	1100				
525-690 V 50/60 Hz 3 <sup>~</sup>	NXP 0261 6 A 0 N 0 SSA	261	287	208	312	375	250	200	FR10	500 x 1165 x 506/120	354 x 319 x 230/53 <sup>3)</sup> 350 x 383 x 262/84 <sup>3)</sup> 500 x 1165 x 506/120 500 x 1165 x 506/120
	NXP 0325 6 A 0 N 0 SSA	325	358	261	392	470	315	250			
	NXP 0385 6 A 0 N 0 SSA	385	424	325	488	585	355	315			
	NXP 0416 6 A 0 N 0 SSA*	416	458	325	488	585	400	315			
	NXP 0460 6 A 0 N 0 SSA	460	506	385	578	693	450	355	FR11	709 x 1206 x 506/210	497 x 399 x 244/115 <sup>4)</sup> 497 x 399 x 244/115 <sup>4)</sup> 709 x 1206 x 506/210
	NXP 0502 6 A 0 N 0 SSA	502	552	460	690	828	500	450			
	NXP 0590 6 A 0 N 0 SSA*	590	649	502	753	904	560	500			
	NXP 0650 6 A 0 N 0 SSA	650	715	590	885	1062	630	560	FR12	2 x (500 x 1165 x 506/120)	2 x (350 x 383 x 262/84) 2 x (350 x 383 x 262/84) 2 x (500 x 1165 x 506/120)
	NXP 0750 6 A 0 N 0 SSA	750	825	650	975	1170	710	630			
	NXP 0820 6 A 0 N 0 SSA*	820	902	650	975	1170	800	630			
	NXP 0920 6 A 0 N 0 SSF	920	1012	820	1230	1410	900	800	FR13	2 x (239 x 1030 x 372/67) + 1 x (708 x 1030 x 553/302)	2 x (497 x 449 x 249/130)
	NXP 1030 6 A 0 N 0 SSF	1030	1133	920	1380	1755	1000	900			
	NXP 1180 6 A 0 N 0 SSF*	1180	1298	1030	1463	1755	1150	1000			
	NXP 1500 6 A 0 N 0 SSF	1500	1650	1300	1950	2340	1500	1300	FR14	3 x (239 x 1030 x 372/67) + 2 x (708 x 103 x 553/302) <sup>5)</sup>	3 x (497 x 449 x 249/130) <sup>5)</sup>
NXP 1900 6 A 0 N 0 SSF	1900	2090	1500	2250	2700	1800	1500				
NXP 2250 6 A 0 N 0 SSF*	2250	2475	1900	2782	3335	2000	1800				

\*Max. ambient temperature of +35°C.

<sup>1)</sup> 12-pulse units, 2 x (354 x 319 x 230/53 kg)

<sup>2)</sup> 12-pulse units, 4 x (497 x 449 x 249/130 kg)

<sup>3)</sup> 12-pulse units, 2 x (354 x 319 x 230/53 kg)

<sup>4)</sup> 12-pulse units, 4 x (239 x 1030 x 372/67) + 2 x (708 x 1030 x 372/302 kg)

<sup>5)</sup> 12-pulse units, 4 x (497 x 449 x 249/130 kg)





# VACON® NXP standalone

Premium VACON® NXP drives are also available in standalone IP21 or IP54 enclosures. These units are delivered in a compact enclosure, making them perfect for areas with limited space, while still providing full VACON® NXP control flexibility.

## Robust and reliable

VACON® NXP standalone drives are fully enclosed at the factory and ready for immediate installation. The drive is ideal for pumps, fans and other single drive applications. The drive has integrated fuses as standard and no extra protection components are required. It is also possible to equip the drive with an optional integrated load switch, which further simplifies handling in the field.

## Typical applications

- Auxiliary equipment
- Pump and fans
- Main propulsion and bow thrusters
- Compressors
- Cranes and lifts

## Features

- Extremely compact cabinet enclosure
- Delivered with ultra rapid AC fuses
- Optional built-in brake chopper and
- DC-link connectors

## Benefits

- Maximize the utilization of available space while reducing the overall costs
- No need to consider any additional protection components



VACON® NXP standalone (FR11)

## Hardware configurations

Function	Availability
IP21	Standard
IP54 (FR10 only)	Optional (H: +20mm)
Integrated ultra rapid fuses	Standard
Load switch (IEC or UL version)	Optional
EMC filtering L (EN 61800-3, category C3)	Standard
EMC filtering T (for IT -networks)	Optional
Brake chopper (cabling top entry)	Optional (H: +122 mm)



## Ratings and dimensions

Mains voltage	AC drive type	Loadability				Maximum current $I_s$ [A]	Motor shaft power		Frame size	Dimensions and weight W x H x D (mm)/ kg
		Low (+40°C)		High (+40°C)			400 V / 690 V			
		Rated continuous current $I_n$ [A]	10% overload current [A]	Rated continuous current $I_n$ [A]	50% overload current [A]		10% overload P [kW]	50% overload P [kW]		
380-500 V 50/60 Hz 3 <sup>-</sup>	NXP 0385 5 A 2 L 0 SSA	385	424	300	450	540	200	160	FR10	595 x 2020 x 602/340
	NXP 0460 5 A 2 L 0 SSA	460	506	385	578	693	250	200		
	NXP 0520 5 A 2 L 0 SSA*	520	572	460	690	828	250	250		
	NXP 0590 5 A 2 L 0 SSA	590	649	520	780	936	315	250	FR11	794 x 2020 x 602/470
	NXP 0650 5 A 2 L 0 SSA	650	715	590	885	1062	355	315		
	NXP 0730 5 A 2 L 0 SSA	730	803	650	975	1170	400	355		
525-690 V 50/60 Hz 3 <sup>-</sup>	NXP 0261 6 A 2 L 0 SSA	261	287	208	312	375	250	200	FR10	595 x 2020 x 602/340
	NXP 0325 6 A 2 L 0 SSA	325	358	261	392	470	315	250		
	NXP 0385 6 A 2 L 0 SSA	385	424	325	488	585	355	315		
	NXP 0416 6 A 2 L 0 SSA*	416	458	325	488	585	400	315		
	NXP 0460 6 A 2 L 0 SSA	460	506	385	578	693	450	355	FR11	794 x 2020 x 602/400 794 x 2020 x 602/400 794 x 2020 x 602/470
	NXP 0502 6 A 2 L 0 SSA	502	552	460	690	828	500	450		
	NXP 0590 6 A 2 L 0 SSA*	590	649	502	753	904	560	500		

\*Max. ambient temperature of +35°C.



# VACON® NXC

Our VACON® NXC is designed to meet the most demanding requirements for flexibility, robustness, compactness and service-friendliness. It is a safe choice for any application and available in the 160 to 2000 kW power range and 380-500 V, 525-690 V voltage range.

## Exceptional performance

Our enclosed VACON® NXC variable speed AC drives are compact and well tested to meet harsh operating conditions. They are typically put to work in segments, such as mining, oil and gas, water and wastewater. The reliable thermal handling of the enclosure guarantees extended lifetime of the frequency converter and trouble-free operation in tough environments. Approved EMC solutions ensure reliable operation of the converter without disturbing other electrical equipment.

## User-friendly

VACON® NXC features an easily accessible control compartment for relays, auxiliary terminals and other equipment and ample space around the power terminals allows for easy installation and connection of power cables. Our handy keypad is located on the door with additional door options including indicators, meters and switches. Bottom plates and earthing claps for 360 degree earthing of motor cables are provided as standard.

- Water treatment
- Winches
- Compressors
- Static power supply
- Industrial elevators

## Service-friendly

VACON® NXC enclosures are easy to install with lifting lugs for easy handling and can be wall-mounted or free-standing. VACON® NXP power units are rail-mounted for easy pull-out, and the optional pull-out jig enables hassle-free servicing of the power unit. No additional cooling fans are required in the enclosure IP21/IP54 and the fans can be easily replaced without having to remove the power unit.

## Features

- Robust and type-tested design
- Wide range of standard options
- One of the most compact on the market
- Welded Rittal TS8 frame
- EMC approved (EN61800-3, 2nd env.)
- Service concept with pullout jig
- No additional fans in IP54 enclosure

## Benefits

- Trouble free installation and operation
- Adapts to your needs w/o engineering
- Easy to fit into small spaces
- Global enclosure availability
- Easy to extend
- Fast service and easy maintenance



VACON® NXC (FR10)

## Typical applications

- Pumps and fans
- Extruders
- Main propulsion and bow thrusters
- Wood handling machines
- Conveyors and crushers
- Feeders and mixers
- Test benches





# Ratings and dimensions

## VACON® NXC, 6-pulse supply

Mains voltage	AC drive type	Loadability				Maximum current I <sub>s</sub> [A]	Motor shaft power 400 V / 690 V		Frame size	Dimensions and weight W x H x D (mm)/ kg
		Low (+40°C)		High (+40°C)			10% overload P [kW]	50% overload P [kW]		
		Rated continuous current I <sub>r</sub> [A]	10% overload current [A]	Rated continuous current I <sub>h</sub> [A]	50% overload current [A]					
380-500 V 50/60 Hz 3 <sup>~</sup>	NXC 0261 5 A 2 H 0 SSF	261	287	205	308	349	132	110	FR9	606 x 2275 x 605/371
	NXC 0300 5 A 2 H 0 SSF	300	330	245	368	444	160	132		
	NXC 0385 5 A 2 L 0 SSF	385	424	300	450	540	200	160	FR10	606 x 2275 x 605/403
	NXC 0460 5 A 2 L 0 SSF	460	506	385	578	693	250	200		
	NXC 0520 5 A 2 L 0 SSF*	520	572	460	690	828	250	250		
	NXC 0590 5 A 2 L 0 SSF	590	649	520	780	936	315	250	FR11	806 x 2275 x 605/577
	NXC 0650 5 A 2 L 0 SSF	650	715	590	885	1062	355	315		
	NXC 0730 5 A 2 L 0 SSF	730	803	650	975	1170	400	355	FR12	1206 x 2275 x 605/810
	NXC 0820 5 A 2 L 0 SSF	820	902	730	1095	1314	450	400		
	NXC 0920 5 A 2 L 0 SSF	920	1012	820	1230	1476	500	450		
	NXC 1030 5 A 2 L 0 SSF	1030	1133	920	1380	1656	560	500		
	NXC 1150 5 A 2 L 0 SSF	1150	1265	1030	1545	1854	630	560	FR13	1406 x 2275 x 605/1000 1606 x 2275 x 605/1150
	NXC 1300 5 A 2 L 0 SSF	1300	1430	1150	1725	2070	710	630		
	NXC 1450 5 A 2 L 0 SSF	1450	1595	1300	1950	2340	800	710	FR14	1606 x 2275 x 605/1150 2806 x 2275 x 605/2440
NXC 1770 5 A 2 L 0 SSF	1770	1947	1600	2400	2880	1000	900			
NXC 2150 5 A 2 L 0 SSF	2150	2365	1940	2910	3492	1200	1100			
525-690 V 50/60 Hz 3 <sup>~</sup>	NXC 0125 6 A 2 L 0 SSF	125	138	100	150	200	110	90	FR9	606 x 2275 x 605/371
	NXC 0144 6 A 2 L 0 SSF	144	158	125	188	213	132	110		
	NXC 0170 6 A 2 L 0 SSF	170	187	144	216	245	160	132		
	NXC 0208 6 A 2 L 0 SSF	208	229	170	255	289	200	160		
	NXC 0261 6 A 2 L 0 SSF	261	287	208	312	375	250	200	FR10	606 x 2275 x 605/371
	NXC 0325 6 A 2 L 0 SSF	325	358	261	392	470	315	250		
	NXC 0385 6 A 2 L 0 SSF	385	424	325	488	585	355	315		
	NXC 0416 6 A 2 L 0 SSF*	416	458	325	488	585	400	315		
	NXC 0460 6 A 2 L 0 SSF	460	506	385	578	693	450	355	FR11	806 x 2275 x 605/524 806 x 2275 x 605/577
	NXC 0502 6 A 2 L 0 SSF	502	552	460	690	828	500	450		
	NXC 0590 6 A 2 L 0 SSF*	590	649	502	753	904	560	500	FR12	1206 x 2275 x 605/745
	NXC 0650 6 A 2 L 0 SSF	650	715	590	885	1062	630	560		
	NXC 0750 6 A 2 L 0 SSF	750	825	650	975	1170	710	630	FR13	1406 x 2275 x 605/1000
	NXC 0820 6 A 2 L 0 SSF*	820	902	650	975	1170	800	630		
	NXC 0920 6 A 2 L 0 SSF	920	1012	820	1230	1410	900	800	FR14	2406 x 2275 x 605/2350 2806 x 2275 x 605/2440 2806 x 2275 x 605/2500
	NXC 1030 6 A 2 L 0 SSF	1030	1133	920	1380	1755	1000	900		
	NXC 1180 6 A 2 L 0 SSF*	1180	1298	1030	1463	1755	1150	1000		
	NXC 1500 6 A 2 L 0 SSF	1500	1650	1300	1950	2340	1500	1300		
NXC 1900 6 A 2 L 0 SSF	1900	2090	1500	2250	2700	1800	1500			
NXC 2250 6 A 2 L 0 SSF*	2250	2475	1900	2782	3335	2000	1800			

\*Max. ambient temperature of +35°C.

# Ratings and dimensions

## VACON® NXC, 12 -pulse supply

Mains voltage	AC drive type	Loadability					Motor shaft power			Frame size	Dimensions and weight W x H x D (mm)/ kg
		Low (+40°C)		High (+40°C)		Maximum current I <sub>S</sub> [A]	400 V / 690 V				
		Rated continuous current I <sub>L</sub> [A]	10% overload current [A]	Rated continuous current I <sub>H</sub> [A]	50% overload current [A]		10% overload P [kW]	50% overload P [kW]			
380-500 V 50/60 Hz 3~	NXC 0385 5 A 2 L 0 TSF	385	424	300	450	540	200	160	FR10	606 x 2275 x 605/371	
	NXC 0460 5 A 2 L 0 TSF	460	506	385	578	693	250	200		606 x 2275 x 605/403	
	NXC 0520 5 A 2 L 0 TSF*	520	572	460	690	828	250	250		606 x 2275 x 605/403	
	NXC 0590 5 A 2 L 0 TSF	590	649	520	780	936	315	250	FR11	806 x 2275 x 605/577	
	NXC 0650 5 A 2 L 0 TSF	650	715	590	885	1062	355	315		806 x 2275 x 605/577	
	NXC 0730 5 A 2 L 0 TSF	730	803	650	975	1170	400	355		806 x 2275 x 605/577	
	NXC 0820 5 A 2 L 0 TSF	820	902	730	1095	1314	450	400	FR12	1206 x 2275 x 605/810	
	NXC 0920 5 A 2 L 0 TSF	920	1012	820	1230	1476	500	450		1206 x 2275 x 605/810	
	NXC 1030 5 A 2 L 0 TSF	1030	1133	920	1380	1656	560	500		1206 x 2275 x 605/810	
	NXC 1150 5 A 2 L 0 TSF	1150	1265	1030	1545	1854	630	560	FR13	1406 x 2275 x 605/1000	
	NXC 1300 5 A 2 L 0 TSF	1300	1430	1150	1725	2070	710	630		2006 x 2275 x 605/1150	
	NXC 1450 5 A 2 L 0 TSF	1450	1595	1300	1950	2340	800	710		2006 x 2275 x 605/1150	
	NXC 1770 5 A 2 L 0 TSF	1770	1947	1600	2400	2880	1000	900	FR14	2806 x 2275 x 605/2440	
	NXC 2150 5 A 2 L 0 TSF	2150	2365	1940	2910	3492	1200	1100		2806 x 2275 x 605/2500	
NXC 0261 6 A 2 L 0 TSF	261	287	208	312	375	250	200	FR10		606 x 2275 x 605/341	
NXC 0325 6 A 2 L 0 TSF	325	358	261	392	470	315	250		606 x 2275 x 605/371		
NXC 0385 6 A 2 L 0 TSF	385	424	325	488	585	355	315		606 x 2275 x 605/371		
NXC 0416 6 A 2 L 0 TSF*	416	458	325	488	585	400	315	FR11	606 x 2275 x 605/403		
NXC 0460 6 A 2 L 0 TSF	460	506	385	578	693	450	355		806 x 2275 x 605/524		
NXC 0502 6 A 2 L 0 TSF	502	552	460	690	828	500	450		806 x 2275 x 605/524		
NXC 0590 6 A 2 L 0 TSF*	590	649	502	753	904	560	500	FR12	806 x 2275 x 605/577		
NXC 0650 6 A 2 L 0 TSF	650	715	590	885	1062	630	560		1206 x 2275 x 605/745		
NXC 0750 6 A 2 L 0 TSF	750	825	650	975	1170	710	630		1206 x 2275 x 605/745		
NXC 0820 6 A 2 L 0 TSF*	820	902	650	975	1170	800	630	FR13	1206 x 2275 x 605/745		
NXC 0920 6 A 2 L 0 TSF	920	1012	820	1230	1410	900	800		1406 x 2275 x 605/1000		
NXC 1030 6 A 2 L 0 TSF	1030	1133	920	1380	1755	1000	900		1406 x 2275 x 605/1000		
NXC 1180 6 A 2 L 0 TSF*	1180	1298	1030	1463	1755	1150	1000	FR14	1406 x 2275 x 605/1000		
NXC 1500 6 A 2 L 0 TSF	1500	1650	1300	1950	2340	1500	1300		2806 x 2275 x 605/2440		
NXC 1900 6 A 2 L 0 TSF	1900	2090	1500	2250	2700	1800	1500		2806 x 2275 x 605/2440		
NXC 2250 6 A 2 L 0 TSF*	2250	2475	1900	2782	3335	2000	1800	2806 x 2275 x 605/2500			

\*Max. ambient temperature of +35°C.

## Hardware configurations, 6-pulse supply

6-pulse	Enclosure		EMC			Brake chopper	Cabling		Input device					Output filters			
	IP21	IP54	L	T	H		Bottom	Top +CIT/+COT	+IFU	+ILS	+IFD	+ICO	+ICB	+OCM/+OCH	+ODU	+OSI	
380-500 V	FR9	S	O (H: +130)	S	O	-	O	S	O (W: +400)	O	O	O	O	O	O	O	O (W: +600)
	FR10	S	O (H: +130)	S	O	-	O	S	O (W: +400)	O	O	O	O	O	O	O (W: +400)	O (W: +600)
	FR11	S	O (H: +130)*	S	O	-	O	S	O (W: +400)	O	O	O	O	O	O	O (W: +400)	O (W: +600-800)
	FR12	S	O (H: +130)	S	O	-	O	S	O (W: +400)	O	O	O	O	O	O	O (W: +400)	O (W: +1200)
	FR13	S	O (H: +170)	S	O	-	1	S	O (W: +400)	-	-	S	-	O	O	O	O (W: +800)
	FR14	S	O (H: +170)	S	O	-	1	S	O (W: +600)	-	-	-	-	S	O	S	O (W: +1600)
500-690 V	FR9	S	O (H: +130)	S	O	-	O	S	O (W: +400)	O	O	O	O	O	O	O	O (W: +600)
	FR10	S	O (H: +130)	S	O	-	O	S	O (W: +400)	O	O	O	O	O	O	O (W: +400)	O (W: +600)
	FR11	S	O (H: +130)*	S	O	-	O	S	O (W: +400)	O	O	O	O	O	O	O (W: +400)	O (W: +600-800)
	FR12	S	O (H: +130)	S	O	-	O	S	O (W: +400)	O	O	O	O	O	O	O (W: +400)	O (W: +1200)
	FR13	S	O (H: +170)	S	O	-	1	S	O (W: +400)	-	-	S	-	O	O	O	O (W: +800)
	FR14	S	O (H: +170)	S	O	-	1	S	O (W: +600)	-	-	-	-	S	O	S	O (W: +1600)

S = Standard O = Optional

<sup>1)</sup>(W: +400) = Contact factory\* NXC07305 and NXC05906, H: +170 mm

## Hardware configurations, 12-pulse supply

12-pulse	Enclosure		EMC			Brake chopper	Cabling		Input device					Output filters			
	IP21	IP54	L	T	H		Bottom	Top +CIT/+COT	+IFU	+ILS	+IFD	+ICO	+ICB	+OCM/+OCH	+ODU	+OSI	
380-500 V	FR10	S	O (H: +130)	S	O	-	-	S	O (W: +400)	O	-	-	-	O	O	O (W: +400)	O (W: +600)
	FR11	S	O (H: +130)*	S	O	-	O	S	O (W: +400)	O	O	O	O	O	O	O (W: +400)	O (W: +600)
	FR12	S	O (H: +130)	S	O	-	O	S	O (W: +400)	O	O	O	O	O	O	O (W: +400)	O (W: +1200)
	FR13	S	O (H: +170)	S	O	-	1	S	O (W: +400)	-	-	-	-	S	O	O	O (W: +800)
	FR14	S	O (H: +170)	S	O	-	1	S	O (W: +800)	-	-	-	-	S	O	S	O (W: +1600)
500-690 V	FR10	S	O (H: +130)	S	O	-	-	S	O (W: +400)	O	-	-	-	O	O	O (W: +400)	O (W: +600)
	FR11	S	O (H: +130)*	S	O	-	O	S	O (W: +400)	O	O	O	O	O	O	O (W: +400)	O (W: +600-800)
	FR12	S	O (H: +130)	S	O	-	O	S	O (W: +400)	O	O	O	O	O	O	O (W: +400)	O (W: +1200)
	FR13	S	O (H: +170)	S	O	-	1	S	O (W: +400)	-	-	-	-	S	O	O	O (W: +800)

S = Standard O = Optional

<sup>1)</sup>(W: +400) = Contact factory

\*NXC07305 and NXC05906, H: +170 mm



### **Pure performance**

Rising energy prices, environmental legislation and process improvement are key issues when designing water handling systems. Use of VACON® AC drives for flow and pressure control instead of dampers or valves gives substantial energy savings resulting in quick ROI.





## VACON® NXC Low Harmonic

The VACON® NXC Low Harmonic drive is the perfect choice for applications where low harmonics are required. This drive not only meets the most demanding requirements for clean power but also provides other important benefits such as regenerative braking and voltage boost for maximum output power.

### Clean power saves money

The low harmonic cabinet drive offers an excellent total solution to meet even the most demanding power quality requirements. The drive also complies with the IEEE-519, G5/4 harmonic standards.

The low THDi reduces supply currents and allows supply transformers, protection devices and power cables to be dimensioned according to the actual active power. It creates savings

for both new and retrofit projects as there's no need to invest in expensive 12- or 18-pulse transformers.

### Typical applications

- Pumps and fans
- Water treatment
- Thrusters and main propulsion
- Crushers and conveyors and mills
- Industrial elevators
- Test benches
- Sugar refineries

### Features

- Clean power with total current harmonics THDi < 5%
- Over-dimensioning of power transformer or input cables is not required
- Regenerative function available
- Reducing system complexity
- No need for special 12-pulse transformers
- Well-suited for retrofit projects
- Increased flexibility with a wide range of standard options

### Benefits

- Over-dimensioning of input components is not needed, reducing the total costs
- Voltage boost function for maximum output power
- Braking energy can be fed back to network saving energy costs
- Reduces overall investment costs and optimizes the use of available space



VACON® NXC Low Harmonic (AF10)



# Ratings and dimensions

Mains voltage	Low harmonic drive type	Loadability				Maximum current I <sub>s</sub> [A]	Motor shaft power		Frame size	Dimensions and weight W x H x D (mm)/kg
		Low (+40°C)		High (+40°C)			400 V / 690 V			
		Rated continuous current I <sub>n</sub> [A]	10% overload current [A]	Rated continuous current I <sub>n</sub> [A]	50% overload current [A]		10% overload P [kW]	50% overload P [kW]		
380-500 V 50/60 Hz	NXC 0261 5 A 2 L 0 RSF	261	287	205	308	349	132	110	AF9	1006 x 2275 x 605/680
	NXC 0300 5 A 2 L 0 RSF	300	330	245	368	444	160	132		
	NXC 0385 5 A 2 L 0 RSF	385	424	300	450	540	200	160		
	NXC 0460 5 A 2 L 0 RSF	460	506	385	578	693	250	200	AF10	1006 x 2275 x 605/700
	NXC 0520 5 A 2 L 0 RSF*	520	572	460	690	828	250	250		
	NXC 0650 5 A 2 L 0 RSF	650	715	590	885	1062	355	315		
	NXC 0730 5 A 2 L 0 RSF	730	803	650	975	1170	400	355	AF12	2006 x 2275 x 605/1400
	NXC 0820 5 A 2 L 0 RSF	820	902	730	1095	1314	450	400		
	NXC 0920 5 A 2 L 0 RSF	920	1012	820	1230	1476	500	450		
	NXC 1030 5 A 2 L 0 RSF	1030	1133	920	1380	1656	560	500	AF13	2206 x 2275 x 605/1950
	NXC 1150 5 A 2 L 0 RSF	1150	1265	1030	1545	1854	630	560		
	NXC 1300 5 A 2 L 0 RSF	1300	1430	1150	1725	2070	710	630		
	NXC 1450 5 A 2 L 0 RSF	1450	1595	1300	1950	2340	800	710	AF14	4406 x 2275 x 605/3900
	NXC 1770 5 A 2 L 0 RSF	1770	1947	1600	2400	2880	1000	900		
NXC 2150 5 A 2 L 0 RSF	2150	2365	1940	2910	3492	1200	1100			
NXC 2700 5 A 2 L 0 RSF	2700	2970	2300	3278	3933	1500	1200			
525-690 V 50/60 Hz	NXC 0125 6 A 2 L 0 RSF	125	138	100	150	200	110	90	AF9	1006 x 2275 x 605/680
	NXC 0144 6 A 2 L 0 RSF	144	158	125	188	213	132	110		
	NXC 0170 6 A 2 L 0 RSF	170	187	144	216	245	160	132		
	NXC 0208 6 A 2 L 0 RSF*	208	229	170	255	289	200	160	AF10	1006 x 2275 x 605/700
	NXC 0261 6 A 2 L 0 RSF	261	287	208	312	375	250	200		
	NXC 0325 6 A 2 L 0 RSF	325	358	261	392	470	315	250		
	NXC 0385 6 A 2 L 0 RSF	385	424	325	488	585	355	315	AF12	2006 x 2275 x 605/1400
	NXC 0416 6 A 2 L 0 RSF*	416	416	325	488	585	400	315		
	NXC 0460 6 A 2 L 0 RSF	460	506	385	578	693	450	355		
	NXC 0502 6 A 2 L 0 RSF	502	552	460	690	828	500	450	AF13	2206 x 2275 x 605/1950
	NXC 0590 6 A 2 L 0 RSF	590	649	502	753	904	560	500		
	NXC 0650 6 A 2 L 0 RSF	650	715	590	885	1062	630	560		
	NXC 0750 6 A 2 L 0 RSF	750	825	650	975	1170	710	630	AF14	4406 x 2275 x 605/3900
	NXC 0820 6 A 2 L 0 RSF*	820	902	650	975	1170	750	650		
	NXC 0920 6 A 2 L 0 RSF	920	1012	820	1230	1476	900	800		
	NXC 1030 6 A 2 L 0 RSF	1030	1133	920	1380	1656	1000	900		
	NXC 1180 6 A 2 L 0 RSF*	1180	1298	1030	1463	1755	1150	1000		
	NXC 1500 6 A 2 L 0 RSF	1500	1650	1300	1950	2340	1500	1300		
	NXC 1900 6 A 2 L 0 RSF	1900	2090	1500	2250	2700	1800	1500		
	NXC 2250 6 A 2 L 0 RSF*	2250	2475	1900	2782	3335	2000	1800		

\*Max. ambient temperature of +35°C.

## Hardware configurations

Active front-end	Enclosure		EMC		Brake chopper	Cabling		Input device	Output filters		
	IP21	IP54	L	T		Bottom	Top +CIT/+COT		+ILS & +ICB	+OCM/+OCH	+ODU
380-500 V											
AF9	S	O (H: +130)	S	O	* (W: +400)	S	O (W: +400)	S	O	O (W: +400)	O (W: +600)
AF10	S	O (H: +130)	S	O	* (W: +400)	S	O (W: +400)	S	O	O (W: +400)	O (W: +600)
AF12	S	O (H: +130)	S	O	* (W: +400)	S	O (W: +400)	S	O	O (W: +400)	O (W: +1200)
AF13	S	O (H: +170)	S	O	* (W: +400)	S	O (W: +400)	S	O	O	O (W: +800)
AF14	S	O (H: +170)	S	O	* (W: +400)	S	O (W: +600)	S	O	S	O (W: +1600)
525-690 V											
AF9	S	O (H: +130)	S	O	* (W: +400)	S	O (W: +400)	S	O	O (W: +400)	O (W: +600)
AF10	S	O (H: +130)	S	O	* (W: +400)	S	O (W: +400)	S	O	O (W: +400)	O (W: +600)
AF12	S	O (H: +130)	S	O	* (W: +400)	S	O (W: +400)	S	O	O (W: +400)	O (W: +1200)
AF13	S	O (H: +170)	S	O	* z(W: +400)	S	O (W: +400)	S	O	O	O (W: +800)
AF14	S	O (H: +170)	S	O	* (W: +400)	S	O (W: +600)	S	O	S	O (W: +1600)

S = Standard O = Optional  
\*Contact factory

# Technical data

<b>Mains connection</b>	Input voltage $U_n$	208...240 V; 380...500 V; 525...690 V; $-10\% \dots +10\%$	
	Input frequency	45...66 Hz	
	Connection to mains	Once per minute or less (normal case)	
<b>Motor connection</b>	Output voltage	0 – $U_n$	
	Continuous output current	High overloadability: IH, ambient temperature max. $+50\text{ }^\circ\text{C}$ ( $\geq\text{FR10} + 40\text{ }^\circ\text{C}$ ) Low overloadability: IL, ambient temperature max. $+40\text{ }^\circ\text{C}$	
	Overloadability	High: $1.5 \times \text{IH}$ (1 min/10 min), Low: $1.1 \times \text{IL}$ (1 min/10 min)	
	Max. starting current	$I_s$ for 2 s every 20 s	
	Output frequency	0...320 Hz	
<b>Control characteristics</b>	Control performance	Open loop vector control (5-150% of base speed): speed control 0.5%, dynamic 0.3%/sec, torque lin. <2%, torque rise time ~5 ms Closed loop vector control (entire speed range): speed control 0.01%, dynamic 0.2% sec, torque lin. <2%, torque rise time ~2 ms	
	Switching frequency	NX_2/ NX_5: Up to and including NX_0061: 1...16 kHz; Factory default 10 kHz  NX_6: From NX_0072: 1...6 kHz; Factory default 3.6 kHz 1...6 kHz; Factory default 1.5 kHz	
	Field weakening point	8...320 Hz	
	Acceleration time	0...3000 sec	
	Deceleration time	0...3000 sec	
	Braking	DC brake: 30% of TN (without brake resistor), flux braking	
	Ambient operating temperature	$-10\text{ }^\circ\text{C}$ (no frost)... $+50\text{ }^\circ\text{C}$ : IH ( $\geq\text{FR10} + 40\text{ }^\circ\text{C}$ ) $-10\text{ }^\circ\text{C}$ (no frost)... $+40\text{ }^\circ\text{C}$ : IL	
	Storage temperature	$-40\text{ }^\circ\text{C}$ ... $+70\text{ }^\circ\text{C}$	
<b>Ambient conditions</b>	Relative humidity	0 to 95% RH, non-condensing, non-corrosive, no dripping water	
	Air quality: – chemical vapours – mechanical particles	IEC 60721-3-3, unit in operation, class 3C2 (tested in accordance with IEC60068-2-60, Method I C CH <sub>2</sub> and SO <sub>2</sub> ) IEC 60721-3-3, unit in operation, class 3S2	
	Altitude	100% load capacity (no derating) up to 1000 m 1% derating for each 100 m above 1000 m; max. 3000 m (690 V max. 2000 m)	
	Vibration EN 50178/EN 60068-2-6	5...150 Hz: Displacement amplitude 1 mm (peak) at 5...15.8 Hz ( $\geq\text{FR10}$ : 0.25 mm (peak) at 5...31 Hz) Max acceleration amplitude 1 G at 15.8...150 Hz ( $\geq\text{FR10}$ : 1 G at 31...150 Hz)	
	Shock EN 50178, EN 60068-2-27	UPS Drop Test (for applicable UPS weights) Storage and shipping: max 15 G, 11 ms (in package)	
	<b>EMC</b>	Immunity	Fulfils all EMC immunity requirements
		Emissions	EMC level C: EN 61800-3, category C1 EMC level H: EN 61800-3, category C2 EMC level L: EN 61800-3, category C3 EMC level T: Low earth-current solution is suitable for IT networks, (can be modified from L/H-level units)
<b>Safety</b>		EN 50178, EN 60204-1, IEC 61800-5-1, CE, UL, CUL; (see unit nameplate for more details)	
<b>Functional safety *</b>	STO	EN/IEC 61800-5-2 Safe Torque Off (STO) SIL2, EN ISO 13849-1 PL'd* Category 3, EN 62061: SILCL2, IEC 61508: SIL2	
	SS1	EN /IEC 61800-5-2 Safe Stop 1 (SS1) SIL2, EN ISO 13849-1 PL'd* Category 3, EN /IEC62061: SILCL2, IEC 61508: SIL2.	
	ATEX Thermistor input	94/9/EC, CE 0537 Ex 11 (2) GD	
	Advance safety option	STO (+SBC),SS1,SS2, SOS,SLS,SMS,SSM,SSR	
<b>Control connections (OPT-A1, -A2 or OPT-A1, -A3)</b>	Analogue input voltage	0...+10 V ( $-10\text{ V} \dots +10\text{ V}$ joystick control), $R_i = 200\text{ k}\Omega$ , resolution 0.1%, accuracy $\pm 1\%$	
	Analogue input current	0(4)...20 mA, $R_i = 250\text{ }\Omega$ differential, resolution 0.1%, accuracy $\pm 1\%$	
	Digital inputs	6, positive or negative logic; 18...30 VDC	
	Auxiliary voltage	+24 V, $\pm 15\%$ , max. 250 mA	
	Output reference voltage	+10 V, +3%, max. load 10 mA	
	Analogue output	0 (4)...20 mA; $R_L$ max. 500 $\Omega$ , resolution 10 bit, accuracy $\pm 2\%$	
	Digital output	Open collector output, 50 mA/48 V	
Relay outputs	2 programmable change-over (NO/NC) relay outputs (OPT-A3: NO/NC+NO) Switching capacity: 24 VDC/8 A, 250 VAC/8 A, 125 VDC/0.4 A. Min. switching load: 5 V/10 mA		
Thermistor input (OPT-A3)	Galvanically isolated, $R_{trip} = 4.7\text{ k}\Omega$		
<b>Protections</b>		Overvoltage, undervoltage, earth fault, mains supervision, motor phase supervision, overcurrent, unit overtemperature, motor overload, motor stall, motor underload, short-circuit of +24 V and +10 V reference voltages	

\*With OPT-AF board



# Option boards

Type	Description	Card slot					I / O signal																									
		A	B	C	D	E	DI	DO	DI/DO	AI (mA/V/±V)	AI (mA) isolated	AO (mA/V)	AO (mA) isolated	RO (NO/NC)	RO (NO)	+10Vref	Therm	+24V/EXT +24V	pt100	KTY84	42-240 VAC input	DI/DO (10...24V)	DI/DO (RS422)	DI ~ 1Vp-p	Resolver	Out +5V/+15V/+24V	Out +15V/+24V	Out +5V/+12V/+15V				
<b>Basic I/O cards (OPTA)</b>																																
OPTA1	DI/DO/AI/AO/ 10V/ 24V						6	1		2		1				1		2														
OPTA2	Relay output (NO/NC)													2																		
OPTA3	Relay output + Thermistor input													1	1		1															
OPTA4	Encoder TTL type						2																3/0			1						
OPTA5	Encoder HTL type						2															3/0					1					
OPTA7	Double encoder HTL type																					6/2					1					
OPTA8	"OPTA1 + Analogue signals galvanically isolated as a group"						6	1		2		1				1		2														
OPTA9	OPTA1 + 2,5mm2 connectors						6	1		2		1				1		2														
OPTAE	Encoder HTL type (Divider + direction)							2														3/0					1					
OPTAF	STO, ATEX therm						2							1	1		1															
OPTAK	Sin/Cos encoder interface																							3			1					
OPTAN	DI/AI/AO						6			2		2																				
<b>I/O expander cards (OPTB)</b>																																
OPTB1	Programmable I/O																	1														
OPTB2	Relay output + Thermistor input													1	1		1															
OPTB4	"Analog input/output Analogue signals galvanically isolated separately"											1		2				1														
OPTB5	Relay output															3																
OPTB8	"Temperature Measurement option PT100"																	1	3													
OPTB9	DI + Relay output						2									1						5										
OPTBH	"Temperature Measurement option pt100, pt1000, Ni1000, KTY84"																		3	3												
OPTBB	EnDat + Sin/Cos 1 Vp-p						2																0/2	2			1					
OPTBC	Resolver, 3xDO (Wide range)																					3/3			1							
OPTBE	EnDat/SSI/BiSS C																															
OPTBL	Advanced safety option						4	2										1														
OPTBM	OPTBL+ HTL/TTL encoder						4	2										1														
OPTBN	OPTBL+ Sin/Cos encoder						4	2										1														
<b>Fieldbus cards (OPTC and OPTE)*</b>																																
OPTE2	RS485 with screw terminal																															
OPTE3	PROFIBUS DP with screw terminal																															
OPTE5	PROFIBUS DP with D9-connector																															
OPTE6	CANopen																															
OPTE7	DeviceNet																															
OPTE8	RS485 with D9-connector																															
OPTE9	Dual-port Ethernet																															
OPTEA	Advanced Dual-port Ethernet																															
OPTC2	RS485 with screw terminal																															
OPTC3	PROFIBUS DP with screw terminal																															
OPTC4	LonWorks																															
OPTC5	PROFIBUS DP with D9-connector																															
OPTC6	CANopen																															
OPTC7	DeviceNet																															
OPTC8	RS485 with D9-connector																															
OPTCI	Modbus/TCP																															
OPTCJ	BACnet MS/TP																															
OPTCP	PROFINET IO																															
OPTCQ	EtherNet/IP																															
<b>Communication cards (OPTD)</b>																																
OPT-D1	SystemBus adapt, 2xfibre-optic																															
OPT-D2	SystemBus (1xfiber), isol. CAN																															
OPT-D3	RS232 adapter (no galv.isol.)																															
OPT-D6	CAN-Bus (galv. decoupled)																															
OPT-D7	Line voltage measurement																															

\*) OPTE series fieldbus cards provide most recent features on market and they are recommended for new installation

- 1) Analogue signals galvanically isolated as a group
- 2) Analogue signals galvanically isolated separately







# VACON® NXC options

Control terminal options (T group)	
+TIO	Basic I/O wired to external single-tier terminals
+TID	Basic I/O wired to external two-tier terminals + additional terminals
+TUP*	Terminals for 230 VAC control voltage
Input device options (I group)	
+ILS*	Load switch
+IFD	Switch fuse and fuses
+ICB*	Circuit breaker
+ICO	Input contactor
+IFU	Input fuses
Main circuit options (M group)	
+MDC	Terminals in cabinet for DC / brake chopper
Output filter options (O group)	
+OCM	Common mode filters
+OCH	Common mode filters with output terminals
+ODU	du/dt filter
+OSI	Sine wave filter
Protection devices (P group)	
+PTR	External thermistor relay
+PES	Emergency stop (cat 0)
+PED	Emergency stop (cat 1)
+PAP	Arc protection
+PIF	Insulation fault sensor
General options	
+G40	400 mm empty cabinet
+G60	600 mm empty cabinet
+G80	800 mm empty cabinet
+GPL	100 mm base
+GPH	200 mm base
+FAT	Factory acceptance tests
+MAR	Marine construction
+SWP	Seaworthy packing

\*Included as standard in low harmonic drives

Cabling options (C group)	
+CIT	Input (mains) cabling from top
+COT	Output (motor) cabling from top
Auxiliary equipment (A group)	
+AMF	Motor fan control
+AMH	Motor heater feeder
+AMB	Mechanical brake control
+AMO*	Motor operator for +ICB
+ACH	Cabinet heater
+ACL	Cabinet light
+ACR	Control relay
+AAI	Analogue signal isolator
+AAA	Auxiliary contact (control voltage devices)
+AAC	Auxiliary contact (input device)
+AT1	Auxiliary voltage transformer 200 VA
+AT2*	Auxiliary voltage transformer 750 VA
+AT3	Auxiliary voltage transformer 2500 VA
+AT4	Auxiliary voltage transformer 4000 VA
+ADC*	Power supply 24 VDC 2.5 A
+ACS	230 VAC customer socket
Door-mounted options (D group)	
+DLV	Pilot light (Control voltage on)
+DLD	Pilot light (DO1)
+DLF	Pilot light (FLT)
+DLR	Pilot light (RUN)
+DCO*	Main contactor operation switch
+DRO*	Local / Remote operation switch
+DEP	Emergency stop push-button
+DRP	Reset push-button
+DAM	Analogue meter (AO1)
+DAR	Potentiometer for reference
+DCM	Analogue meter & current transformer
+DVM	Analogue voltage meter with selection switch

## EMC selection table

						
VACON® NXP EMC	Hospital	Residential Area	Commercial	Light Industry Area	Heavy Industry	Marine
C (Category C1)	O					
H (Category C2)	R	R	R	O	O	
L (Category C3)				R	R	
T (Category C4)					R (IT)	R (IT)

The product family standard EN 61800-3 sets limits for both emissions and immunity to radio frequency disturbances. The environment has been divided into the first and second environments; in practice, public and industrial networks, respectively.

Radio Frequency Interference (RFI) filters are typically required to meet the EN 61800-3 standard. These filters are integrated in the VACON® NXP as standard.

The 208-240 V and 380 500 V ranges of the VACON® NXP (FR4-FR9) meet the requirements of the first and second environments (H level: EN 61800-3 (2004), category C2). No additional RFI filters or cabinets are required. The FR10-FR14 and the 500-690 V ranges of the VACON® NXP meet the requirements of the second environment (L-level: EN 61800-3(2004), category C3).

The units in the frame sizes FR4, FR5 and FR6 (with a voltage range from 380 to 500 V) are also available with extremely low-emission integrated EMC filters (C level: EN 61800-3 (2004), category C1). This is sometimes required in very sensitive locations, such as hospitals.

# Type code key

**NXC 0520 5 A 2 L O S S F A1 A2 00 00 00 + IFD**

**NXC** — **Product Range**  
**NXP** = Wall-mounted/standalone/module  
**NXC** = Cabinet

**0520** — **Nominal current voltage**  
 0520 = 520 A

**5** — **Nominal mains voltage**  
**2** = 208-240 V  
**5** = 380-500 V  
**6** = 525-690 V

**A** — **Control keypad**  
**A** = Standard alphanumeric  
**B** = No local keypad  
**F** = Dummy keypad  
**G** = Graphic display

**2** — **Enclosure class**  
**5** = IP54, FR4-10; NXC FR9-FR14; AF9-14  
**2** = IP21, FR4-11; NXC FR9-FR14; AF9-14  
**0** = IP00, NXP FR10-14

**L** — **EMC emission levels**  
**C** = Category C1, EN 61800-3  
**H** = Category C2, EN 61800-3  
**L** = Category C3, EN 61800-3  
**T** = For IT networks  
**N** = Enclosure required (FR10-FR14)

**0** — **Brake chopper**  
**0** = No brake chopper  
**1** = Integrated brake chopper

**S** — **Supply**  
**S** = 6-pulse  
**T** = 12-pulse  
**O** = 6-pulse + load switch (standalone)  
**R** = Low Harmonic

**S** — **Cooling**  
**S** = standard air-cooled  
**T** = through-hole mounting FR4-FR9

**F** — **Control**  
**S** = Standard FR4-FR8  
**F** = Standard FR9 and NXC  
**A** = Standard NXP FR10-FR12  
**N** = Standard IP00 ≥ FR10 & NXC with IP54 control unit enclosure  
**V** = As S, but varnished  
**G** = As F, but varnished boards  
**O** = As N, but varnished boards  
**B** = As A, but varnished boards

**A1** — **Option boards; each slot is represented by two characters:**  
**Ax** = Basic I/O boards,  
**Bx** = Expander I/O boards  
**Cx** = Fieldbus boards,  
**Dx** = Special boards

**00**

**00**

**00**

**+**

**IFD** — **NXC options, see tables page 22**



# DrivePro® Life Cycle services

## Delivering a customized service experience!

We understand that every application is different. Having the ability to build a customized service package to suit your specific needs is essential.

DrivePro® Life Cycle Services is a collection of tailor-made products designed around you. Each one engineered to support your business through the different stages of your AC drive's life cycle.

From optimized spare-part packages to condition-monitoring solutions, our products can be customized to help you achieve your business goals.

With the help of these products, we add value to your application by ensuring you get the most out of your AC drive.

When you deal with us, we also offer you access to training, as well as the application knowledge to help you in planning and preparation. Our experts are at your service.

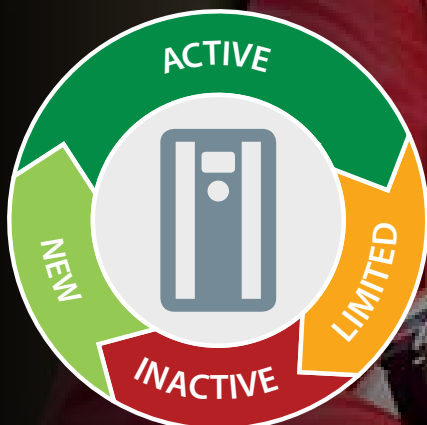

# You're covered

## with DrivePro® Life Cycle service products



### DrivePro® Retrofit

**Minimize the impact and maximize the benefit**

Manage the end of product lifecycle efficiently, with professional help to replace your legacy drives. The DrivePro® Retrofit service ensures optimal uptime and productivity during the smooth replacement process.



### DrivePro® Start-up

**Fine-tune your drive for optimal performance today**

Save on installation and commissioning time and cost. Get help from professional drives experts during start-up, to optimize drives safety, availability and performance.



### DrivePro® Spare Parts

**Plan ahead with your spare part package**

In critical situations, you want no delays. With DrivePro® Spare Parts you always have the right parts on hand, on time. Keep your drives running at top efficiency, and optimize system performance.



### DrivePro® Preventive Maintenance

**Take preventive action**

You receive a maintenance plan and budget, based on an audit of the installation. Then our experts perform the maintenance tasks for you, according to the defined plan.



### DrivePro® Extended Warranty

**Long-term peace of mind**

Get the longest coverage available in the industry, for peace of mind, a strong business case and a stable, reliable budget. You know the annual cost of maintaining your drives, up to six years in advance.



### DrivePro® Remote Expert Support

**You can rely on us every step of the way**

DrivePro® Remote Expert Support offers speedy resolution of on-site issues thanks to timely access to accurate information. With the secure connection, our drives experts analyze issues remotely reducing the time and cost involved in unnecessary service visits.



### DrivePro® Exchange

**The fast, most cost-efficient alternative to repair**

You obtain the fastest, most cost-efficient alternative to repair, when time is critical. You increase uptime, thanks to quick and correct replacement of the drive.



### DrivePro® Remote Monitoring

**Fast resolution of issues**

DrivePro® Remote Monitoring offers you a system that provides online information available for monitoring in real time. It collects all the relevant data and analyzes it so that you can resolve issues before they affect your processes.



### DrivePro® Upgrade

**Maximize your AC drive investment**

Use an expert to replace parts or software in a running unit, so your drive is always up-to-date. You receive an on-site evaluation, an upgrade plan and recommendations for future improvements.

To learn which products are available in your region, please reach out to your local Danfoss Drives sales office or visit our website <http://drives.danfoss.com/danfoss-drives/local-contacts/>



**Stay calm.** You're covered.





## Stay calm. You're covered.

Use the DrivePro® app for fast access to the DrivePro® services, for improved productivity, performance and uptime of your systems. Find your closest service partner, place a service request, and register your AC drives. You can also look up product information, specifications and manuals for your specific drive.

**Quick, simple, reliable. Giving you complete control.**



Follow us and learn more about AC drives





## Danfoss Drives

Danfoss Drives is a world leader in variable speed control of electric motors. We aim to prove to you that a better tomorrow is driven by drives. It is as simple and as ambitious as that.

We offer you unparalleled competitive edge through quality, application-optimized products targeting your needs – and a comprehensive range of product lifecycle services.

You can rely on us to share your goals. Striving for the best possible performance in your applications is our focus. We achieve this by providing the innovative products and application know-how required to optimize efficiency, enhance usability, and reduce complexity.

From supplying individual drive components to planning and delivering complete drive systems; our experts are ready to support you all the way.

We draw on decades of experience within industries that include:

- Chemical
- Cranes and Hoists
- Food and Beverage
- HVAC
- Lifts and Escalators
- Marine and Offshore
- Material Handling
- Mining and Minerals
- Oil and Gas
- Packaging
- Pulp and Paper
- Refrigeration
- Water and Wastewater
- Wind

You will find it easy to do business with us. Online, and locally in more than 50 countries, our experts are never far away, reacting fast when you need them.

Since 1968, we have been pioneers in the drives business. In 2014, Vacon and Danfoss merged, forming one of the largest companies in the industry. Our AC drives can adapt to any motor technology and we supply products in a power range from 0.18 kW to 5.3 MW.

**VLT® | VAGON®**

Danfoss can accept no responsibility for possible errors in catalogues, brochures and other printed material. Danfoss reserves the right to alter its products without notice. This also applies to products already on order provided that such alterations can be made without subsequential changes being necessary in specifications already agreed. All trademarks in this material are property of the respective companies. Danfoss and the Danfoss logotype are trademarks of Danfoss A/S. All rights reserved.